

Ultrasonic Testing Device

SONAPHONE E



Operating Instructions

Manufacturer: SONOTEC Ultraschallsensorik Halle GmbH
Model: Ultrasonic Testing Device
Type: SONAPHONE E

SONOTEC Ultraschallsensorik Halle GmbH
Nauendorfer Str. 2
06112 Halle (Saale), Germany

Telephone: +49 (0) 345 13317-0
Fax: +49 (0) 345 13317-99

E-mail: sonotec@sonotec.de
Internet: www.sonotec.eu

© 2016
SONOTEC Ultraschallsensorik Halle GmbH
All rights reserved

The content of this operating manual is property of SONOTEC Ultraschallsensorik Halle GmbH and protected by copyright. No part of this manual may be translated, copied or reprinted without the explicit written consent of SONOTEC Ultraschallsensorik Halle GmbH.

Revision: 2.3 Date: 2018-07-19

Table of Content

1	Safety precautions	5
1.1	Special safety precautions on the use of the SONAPHONE E in hazardous areas	5
1.2	Safety precautions for the SONAPHONE E in hazardous areas.....	6
1.3	General safety precautions for the SONAPHONE E	8
2	Scope of delivery	9
2.1	Summary.....	9
2.2	Arrangement of devices and accessories in the transport case	10
3	Function description.....	11
3.1	General information.....	11
3.2	SONAPHONE E connections, control- and display elements.....	12
4	Operation	13
4.1	Insert the batteries.....	13
4.2	Starting up the unit	16
4.3	Battery status indicator	16
4.4	Check mode	17
4.5	Main menu	20
4.6	Data logger.....	21
4.7	Test parameters	29
4.8	Settings	31
5	Using the probes.....	33
5.1	Air-borne sound probe L60	33
5.2	Structure-borne sound probe L61 for valve inspection (oil and water resistant)	34
5.3	Structure-borne sound probe L62 for long-time tests and detection of bearing wear	35
5.4	Flexible air-borne sound probe L63	36
6	Using accessories.....	37
6.1	Telescoping rod.....	37
6.2	Surface temperature sensor	38
6.3	Using the grounding set.....	39

7	PC connection & data transfer	40
7.1	Directory structure of the installation CD	41
7.2	Installation for Windows XP / Windows Vista	41
7.3	Installation for Windows 7	43
7.4	Power supply via USB	45
8	Trouble shooting	46
9	Technical specifications	47
10	Warranty	48

1 Safety precautions

1.1 Special safety precautions on the use of the SONAPHONE E in hazardous areas

- (1) Change batteries only outside hazardous areas.
- (2) Exclusively the following alkaline primary cells are approved for the use:
 - Varta High Energy 4906 MN1500
 - Duracell Plus MN1500
- (3) The permissible range of operating temperatures for the SONAPHONE E and the probes is 0 °C ... +40 °C.
- (4) Only the accessories included are allowed to be attached to the SONAPHONE E: headphones, surface temperature sensor, ultrasonic probes, probe accessories, telescoping rod and extra sensor.
- (5) The ultrasonic transmitter SONAPHONE T (optional accessory) is not an explosion-protected device, and must not be taken into or operated in an hazardous area!
- (6) Do not take the carrying case into the hazardous area!
- (7) Only the ultrasonic probes L60 and L61 in connection with the probe extension cable are intended for the use in Ex-zone 0. The SONAPHONE E and the other accessories must not be taken into Ex-zone 0.
- (8) Only the equipment offered by SONOTEC as accessories may be used as extra sensors. If the extra sensor is connected, the complete set of equipment may only be operated in Zone 1 and 2. (protection level drops to “ib”).
- (9) Connect the SONAPHONE E exclusively to normal commercial devices with a maximum voltage of 60 V using a USB cable. This is only ensured for equipment labelled with the CE mark. Connect and operate the USB interface only outside hazardous areas.

1.2 Safety precautions for the SONAPHONE E in hazardous areas

The SONAPHONE E conforms to the best available technology and safety rules. The manufacturer has made every effort to ensure safe operation. The user must make sure that its safe use is not affected. The device has been tested in the factory and was delivered in a safe operating condition.

(1) The device may only be used by persons instructed with its use. All users who work with this device must read these operating instructions first.

(2) The SONAPHONE E is intended for the use in areas in which there is a danger of explosion due to gases, vapours or mist accordance to the device marking. Do not use the device where there is a danger of dust explosions.

SONAPHONE E

II2G Ex ia IIC T4 Gb

The SONAPHONE E, the surface temperature sensor and the headphones conform to EPL (Equipment protection level) b.

Ultrasonic probes L60, L61, L62 and L63

II2G Ex ia IIC T4 Gb

Ultrasonic probes L60 and L61

II1G Ex ia IIB T4 Ga and II2G Ex ia IIC T4 Gb

The ultrasonic probes L60, L61, L62 and L63 conform to EPL (Equipment protection level) b for gas group IIC, IIB and IIA. Furthermore, the ultrasonic probes L60 and L61 conform to EPL (Equipment protection level) a for gas groups IIB and IIA. The ultrasonic probes L60 and L61 may be taken into Ex-zone 0 (only for gas groups IIA and IIB). However, the permanent installation of these probes in Ex-zone 0 is not permitted.

Code for marking explosion protected devices:

Equipment group	II (aboveground applications)
Category group	2 (high safety, suitable for Ex-Zones 1 and 2) 1 (very high security, suitable for Ex-Zones 0, 1 and 2)
Atmosphere	G (gas, dust, vapours)
Type of protection	ia (intrinsic safety)
Gas group	IIA (less ignitable) ... IIB ... IIC (easy to ignite)
Temperature class	T4 Minimum ignition temperature of the atmosphere 135°C
EPL (Equipment protection level)	Explosive gas atmosphere areas: Ga (Zone 0) / Gb (Zone 1)

Local equipotential equalisation may only be done with the earthing set available from SONOTEC Ultraschallsensorik Halle GmbH. Please see the chapter 0 for instructions of the use of the earthing set.

As the probes are made of a light metal alloy, avoid friction and impact sparks which can result from dropping the probes.

(3) The device is suitable for measuring surface temperatures up to 800 °C. Such high temperatures are only encountered outside hazardous areas.

(4) The SONAPHONE E is not authorized for the use in mines susceptible to firedamp.

(5) The SONAPHONE E must be protected against moisture penetration.

(6) Ensure that electrostatic charges do not build up on the plastic parts. Carrying cases, grips, probe accessories, cables and objects coated in plastic must not be rubbed against one another or against other objects. Use a damp cloth to clean the unit and all accessories. Aggressive cleansers may attack the SONAPHONE E's plastic casing and affect its mechanical stability.

(7) You are not allowed to open the SONAPHONE E or its accessories or to perform any unauthorised repairs. This could affect the explosion protection. Repairs may only be carried out by the manufacturer.

1.3 General safety precautions for the SONAPHONE E

- (1) The SONAPHONE E and the probes are suitable for the use at temperatures between 0 and 40 °C. Store the unit at temperatures between -10 °C and +50 °C.
- (2) Make sure that you have a clear view of the SONAPHONE E and the probes at any time of operation. Never work with the probes or the telescoping rod in areas with live parts or areas you do not know exactly. When locating ultrasonic signals in electrical installations, keep a sufficient safety distance to prevent electrical flashover.
- (3) Always handle the probe for structure-borne ultrasound with care, so that the probe tip does not cause any injuries. Use the probe carrier bag on the shoulder strap when carrying it outside the carrying case or when the probe is not in use.
- (4) Use the shoulder strap on stairs, ladders, platforms etc. so that you can have your hands free to brace yourself.
- (5) Avoid using the SONAPHONE E in strong electromagnetic fields.
- (6) The SONAPHONE E is a testing device.
- (7) SONOTEC Ultraschallsensorik Halle GmbH offers no warranty for damages, even for harm to third parties, caused by incorrect handling of the device.
- (8) The SONAPHONE E, the probes and all accessories have a robust casing. However, they must be protected from mechanical damage and sharp impacts. Do not use cleansers containing solvents.

2 Scope of delivery

2.1 Summary

SONAPHONE E testing device

Probes*

- Air-borne sound probe L60
- Structure-borne sound probe L61
- Structure-borne sound probe L62 with stainless steel tip
- Flexible air-borne sound probe L63

Accessories*

- Headphones (with high sound insulation)
- Surface temperature sensor ($T_{\max} = 800 \text{ °C}$)
- Probe extension cable 30 cm
- Extension cable for the surface temperature sensor
- Directional tube with tip
- Acoustic horn (attachment for airborne sound probe L60)
- SONAPHONE T ultrasonic transmitter
- Spherical transmitter SONOSPHERE
- Aluminum telescope bar
- Transport case
- PC software SONAPHONE E Communicator
- USB cable
- Operating instructions
- Grounding set for probes L60 and L61

*) Please do notice, that the scope of delivery varies according to your order.

2.2 Arrangement of devices and accessories in the transport case



- | | | | |
|---|---|----|---|
| 1 | <i>Shoulder strap</i> | 7 | <i>Operating instructions</i> |
| 2 | <i>Structure-borne sound probe L62</i> | 8 | <i>SONAPHONE T</i> |
| 3 | <i>Directional tube with tip</i> | 9 | <i>Flexible air-borne sound probe L63</i> |
| 4 | <i>Surface temperature sensor</i> | 10 | <i>Headphones</i> |
| 5 | <i>Extension cable for the temperature sensor</i> | 11 | <i>SONAPHONE E</i> |
| 6 | <i>Air-borne sound probe L60 with probe extension cable</i> | | |

3 Function description

3.1 General information

Ultrasound is generated due to friction caused by the flow of gases, liquids and solids in pipes and leakages. These ultrasonic signals are recorded by the SONAPHONE E, their intensity is shown on the display screen and made audible through speaker or headphones. As an option, surface temperatures can be measured with a temperature sensor. The recorded data can be stored and transmitted to a personal computer using the integrated USB interface. Ultrasound can be generated in a wide variety of processes, for example:

- at leaks in compressed air-, steam- and vacuum systems
- at steam traps
- at leaky valves, gate valves, shut-offs and valves in pipings
- from roller bearing damages
- from cavitation at pumps and compressors
- from flash-overs and corona discharges on electrical installations

Using the SONAPHONE E, it is possible to locate precisely the defects and estimate their magnitude. The ultrasonic transmitter SONAPHONE T (optional accessory) can be used to detect leaks in vehicles, freight containers, other types of containers and ventilation technique systems where no ultrasound is generated. The SONAPHONE T generates ultrasonic waves which emerge at the leaks. Precise location is carried out from the outside with the SONAPHONE E.

CAUTION!

The ultrasonic transmitter SONAPHONE T (optional accessory) must **not** be taken into or operated in hazardous areas!

The SONAPHONE E tester is a mobile hand-held and battery-supplied unit. Various probes, which are connected directly or via a cable to the tester, serve to detect the ultrasound. The type of probe is automatically recognised by the SONAPHONE E by means of a probe code. A surface temperature sensor (type K thermocouple, NiCr-Ni) with a circular plug-in connector is used for temperature values (optional). It can be extended at any time using a corresponding extension cable.

3.2 SONAPHONE E connections, control- and display elements



4 Operation

4.1 Insert the batteries

Safety notes

- Only the batteries listed in Section 1.1 may be used for operation in hazardous areas.
 - Varta High Energy 4906 MN1500¹
 - Duracell Plus MN1500¹
- The batteries should only be changed when the device is switched off.
- When opening the battery compartment lid, do not have the device connected to a PC through a USB cable.
- When inserting the batteries, make sure the polarity corresponds to the engraved marking on the battery block.
- Follow the instructions below!

Description of the battery change

1. Disconnect the shoulder strap from the battery compartment lid.
2. Turn back the locking screw of the battery compartment all the way until it stops. The battery block will move in the same direction as the locking screw. It is important to hold the battery block and the device firmly.

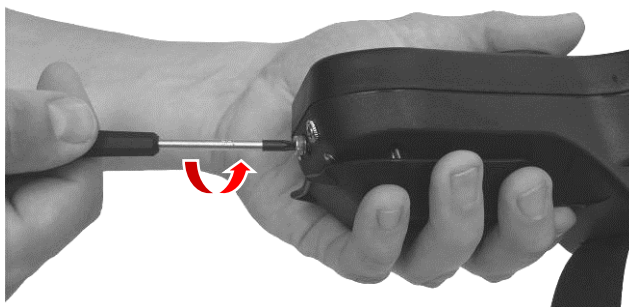

¹ Please contact SONOTEC in case the batteries are not available.

3. Press down the battery compartment and pull it out of the unit.



4. Take the batteries out of the battery block.
5. Insert new batteries into the block, checking that the polarity is correct. An engraving on the top of the battery block illustrates the correct arrangement of the batteries.



6. Re-insert the battery compartment into the casing.



7. Tighten the locking screw of the battery compartment again.
8. Fasten the shoulder strap to the battery compartment lid.

4.2 Starting up the unit

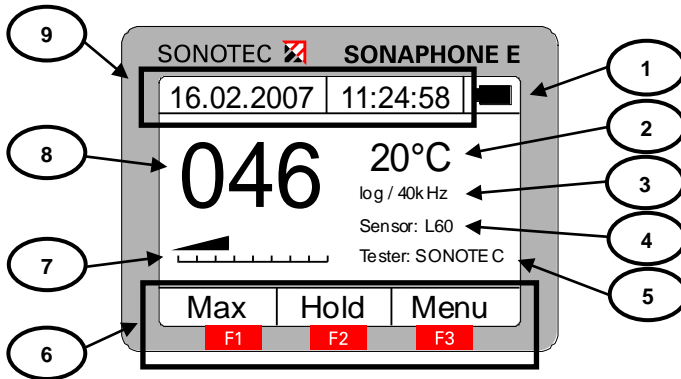

The device is switched on by pressing the ON/OFF button. After displaying the splash screen, it switches automatically to the testing mode. The following is shown on the display:



- | | |
|--|--|
| 1 <i>Battery or USB operation
battery status indicator</i> | 6 <i>Currently available functions
of keys "F1-F3"</i> |
| 2 <i>Temperature</i> | 7 <i>Intensity bar for ultrasonic
test value</i> |
| 3 <i>Testing mode / mixer
frequency</i> | 8 <i>Ultrasonic test value</i> |
| 4 <i>Type of probe</i> | 9 <i>Date / time</i> |
| 5 <i>Tester</i> | |

4.3 Battery status indicator

The symbol (labelled '1' in the above illustration) at the top right edge of the display provides information about the status of the batteries in the unit and about the kind of power supply:

Battery operation (about 60%)	USB operation
	

4.4 Check mode

Control elements

Turning the rotary knob:	Volume adjustment
Pressing the rotary knob:	Storing the test values (see Section: Single test)
F1 (Max):	Turns on or off "Max" function
F2 (Hold):	Turns on or off "Hold" function
F3 (Menu):	Switch to menu in order to adjust the settings of the unit
"LIGHT":	Controls the display lighting (<i>Off – Level I – Level II – Level I – Off</i>)

To switch the unit on or off press the ON/OFF button. Depending on the intended use, connect the appropriate probe or the temperature sensor to the SONAPHONE E (see Section: **Using the probes**).

A probe for structure-borne ultrasound is used for locating leaks. The level of ultrasound is besides the magnitude of the sound source also dependent on the probe's direction and distance from the sound source. This effect can be used to locate and evaluate leaks. If no probe is plugged into the unit, the message "No Probe" is displayed instead of the ultrasound level.

Volume adjustment

When the rotary knob is turned, a volume bar and an intensity value are displayed for about two seconds, as shown below:

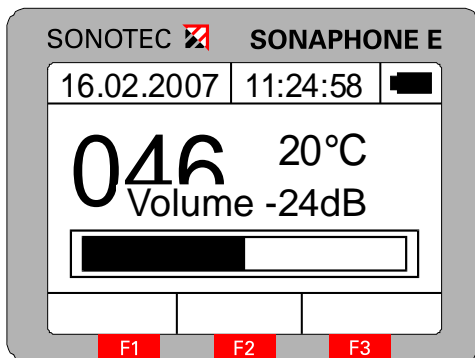

Turning the rotary knob clockwise increases the volume and turning it anti-clockwise decreases the volume.

Storing the test values

When the rotary knob is pressed in the check mode (provided that at least one **Single test** has been prepared), the ultrasonic test values and the current temperature are stored in the individual test selected as "Active". During this process, "Save" and the name of the single test appear briefly on the display:

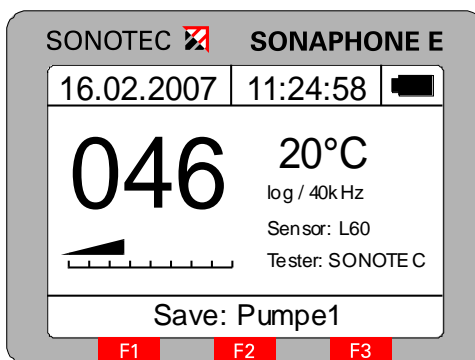

“Max” function

The F1 key activates the “Max” function. In this state, the number displayed corresponds to the maximum ultrasound level and the intensity bar to the current ultrasound level. The activation of the “Max” function is signalled by highlighting the function key description:

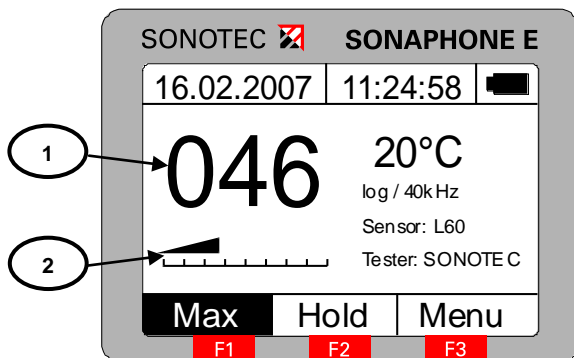

- 1 *Maximum ultrasound level*
- 2 *Current ultrasound level*

Pressing the rotary knob, stores the currently **displayed value**, in other words the maximum value, in the individual test that is active.

Press the „F1” function key again to deactivate the “Max” function.

“Hold” function

Press the F2 function key to activate the “Hold” function. This serves to register ultrasound levels, for example, if the display is not visible at the moment of testing. Thereby, the ultrasound level, which was recorded at the moment the F2 key was pressed, is stored in the display.

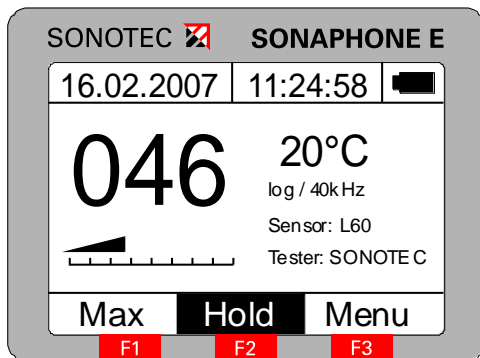

Press the rotary knob to store the currently **displayed value**, in other words the “Hold” value, in the individual test that is active.

Press the F2 key again to deactivate the “Hold” function.

4.5 Main menu

Menu structure

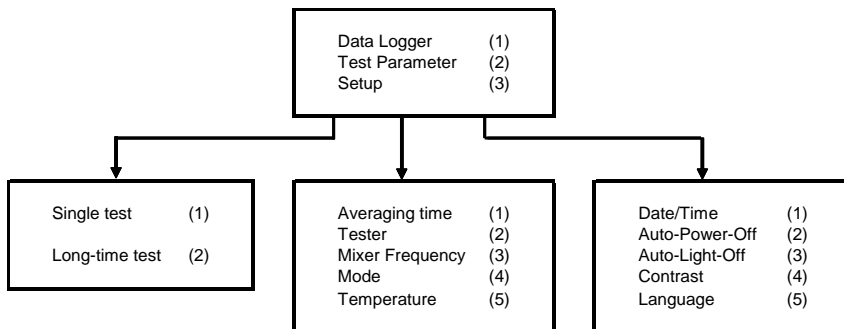

Operation

There is a choice of three menu items in the main menu: the data logger for storing the test values, the test parameters for changing all parameters relevant to the test and the setup for changing the device's parameters. The selection is carried out by turning the rotary knob. Press it to open the respective menu. Press the F3 function key to return the unit to the check mode.

The selected menu item is indicated by a dot in the selection circle:

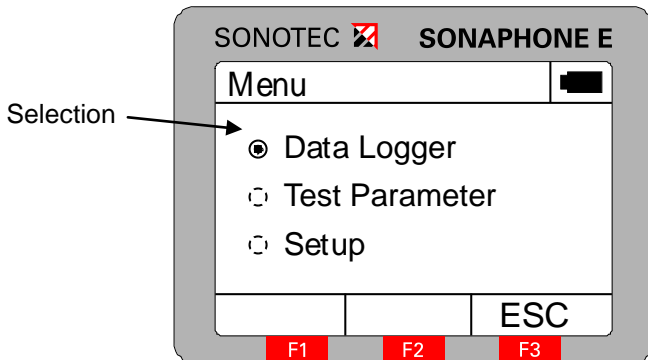

4.6 Data logger

General information

Ultrasound levels and temperature test values can be stored in the data logger. The data record includes the date, the tester (maximum eight characters), the test site (maximum 16 characters), the type of probe used, the ultrasound level and the temperature. There are two kinds of tests:

1. Long-time test: Storing ultrasonic and temperature test values over a longer period at constant time intervals.
A maximum of 250 Long-time tests with 73 datasets each, or 1 Long-time test with 20,000 datasets can be recorded. 1 record consists of the ultrasonic test value and the temperature test value.
2. Single test: Storing current ultrasonic and temperature test values in one file.
A maximum of 250 individual tests with 25 datasets each, or one individual test with 6,000 datasets can be recorded.

Use the PC software SONAPHONE Communicator, available as an accessory, for archiving the measurement data.

Long-time test

Once the Long-time test has been selected, a summary of all Long-time tests created until then appears, showing the respective test site and the date of creation:

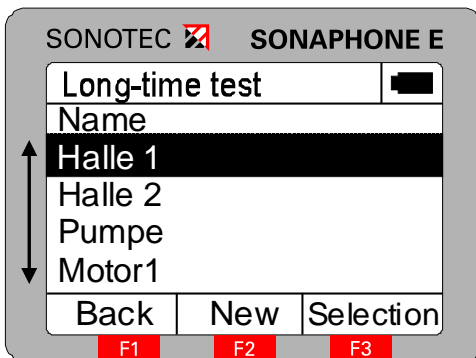
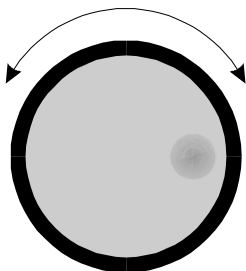

In this menu, the user has a choice of four options:

Pressing the rotary knob:

Detailed information about the selected Long-time test

F1 (Return):

Return to the Data Logger menu

F2 (New):

Create a new Long-time test

F3 (Selection):

Record test values for the selected Long-time test

1. Create new Long-time test

To create a new Long-time test, press function key F2 to open a new screen:

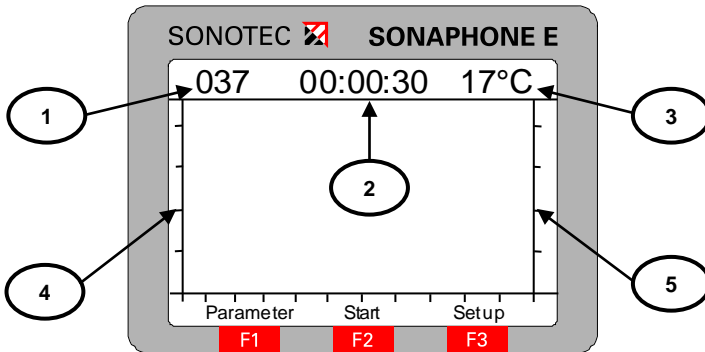

- | | | | |
|---|------------------------------|---|---|
| 1 | <i>Ultrasonic test value</i> | 4 | <i>Scale for the ultrasonic test value</i> |
| 2 | <i>Test duration</i> | 5 | <i>Scale for the temperature test value</i> |
| 3 | <i>Temperature</i> | | |

To set the testing parameters, open the parameter menu using the function key “F1”. In order to make adjustments to the display of the Long-time test, or to end the Long-time test, the menu item “setup” has to be opened by pressing function key “F3”:

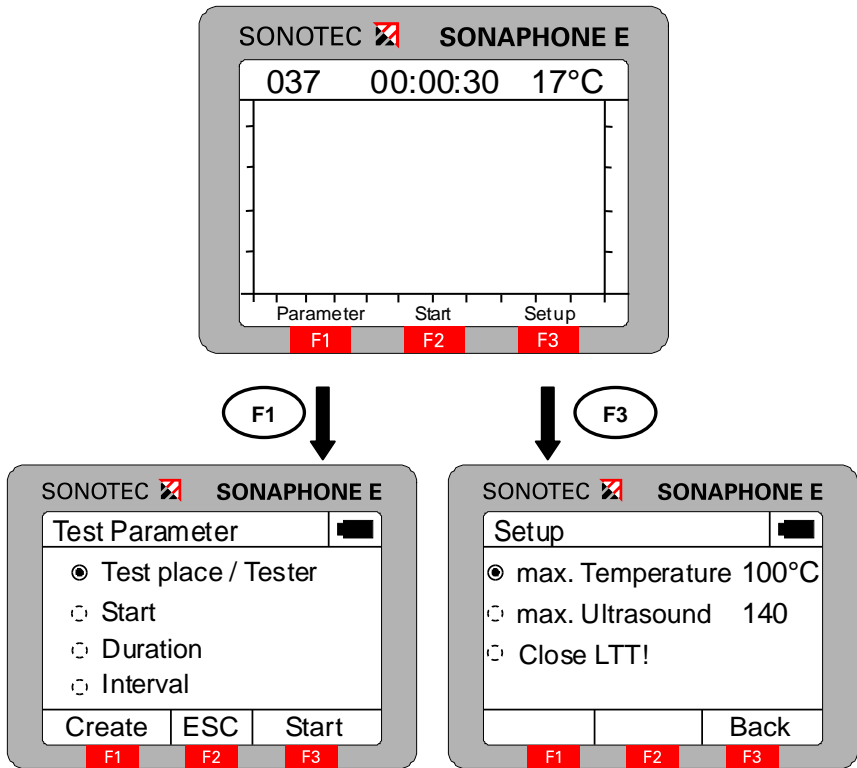

See section **Setting the tester** for instructions on setting the test place and tester. In the start menu, the user can set the type and starting time of the Long-time test:

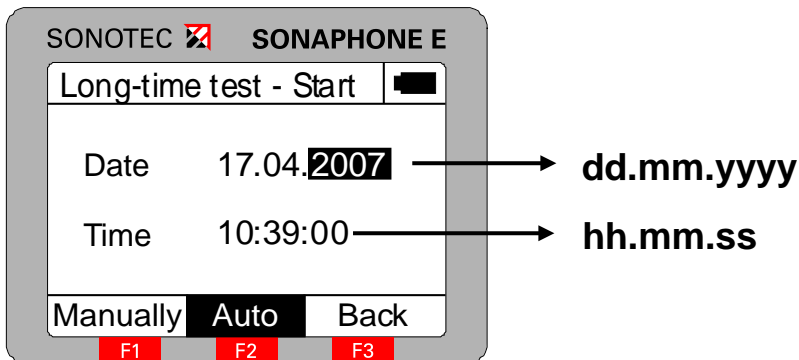

When this menu is opened, the start of the Long-time test is set to “Auto”. The SONAPHONE E will thus start the Long-time test automatically at the time that has been set. If the time entered is earlier than the present time, the test is started immediately. Switching to “manual” enables to start the Long-time test manually. Select the element to be edited by pressing the rotary knob. Adjustments can be made by turning the rotary knob. Press function key F3 to store the starting time for the selected Long-time test.

The scaling of the ultrasonic and temperature test values depends on the limits for maximum temperature and maximum ultrasonic level which have been set under setup.

2. Start the Long-time test

The Long-time test can be manually started in the measuring screen by pressing function key F2:

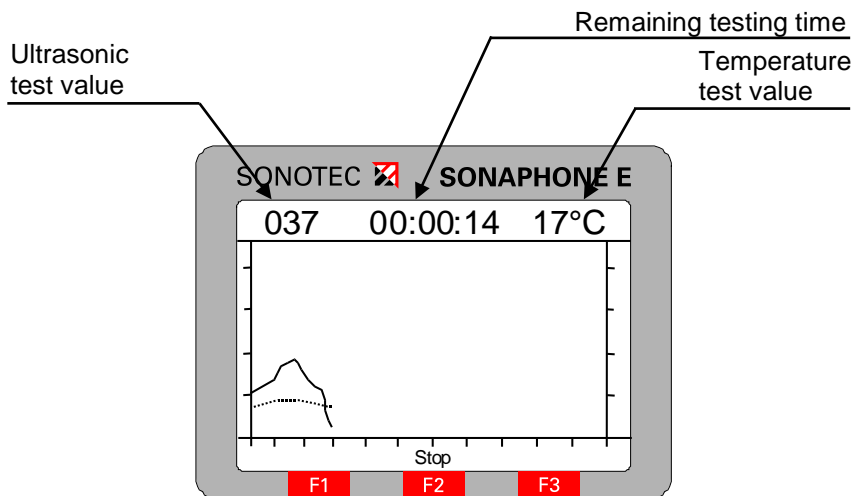

The ultrasonic test values are represented by a solid line, and the temperature values by a dotted line. The remaining time of the test is shown at the top centre of the screen. The Long-time test can be cancelled at any time by pressing function key F2. The values recorded up to that time are stored and the entry for the duration of the test is updated.

3. Finishing the Long-time test

To exit the Long-time recording and to return to the check mode choose "Close LTT!" in the menu setup.

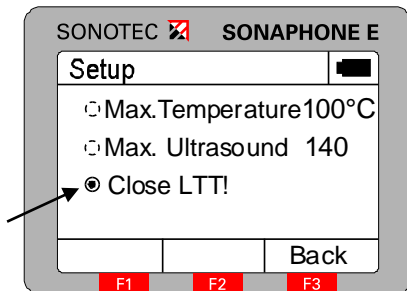

All test values, which have been recorded until this point, are kept and displayed in the overview of the Long-time tests, which are stored in the device.

4. Details of the selected Long-time test

In the following, information about tester, testing site, date, time, duration and intervals of the test is given. Now, you have the option of deleting the Long-time test or viewing the test values in form of a diagram.

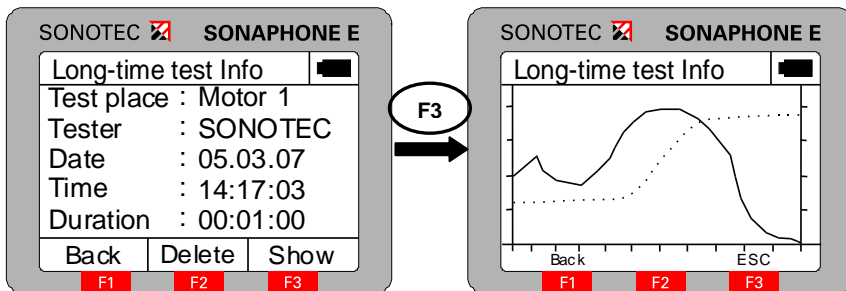

Ultrasonic test values are represented by a solid line and temperature values by a dotted line. The visible time period is a maximum of 60 seconds. If the duration of the test is longer than 60 seconds, it is possible to shift the window of time by turning the rotary knob. The ultrasonic test values are shown over a range of 0 - 140 scale divisions for the logarithmic scaling, and 0 - 240 divisions for the linear scaling. The temperature is shown over the range 0...800 °C or 0...1472 °F.

Press function key F2 in the detail screen to delete the current data record. As a safety measure, you are asked if this record should definitely be deleted:

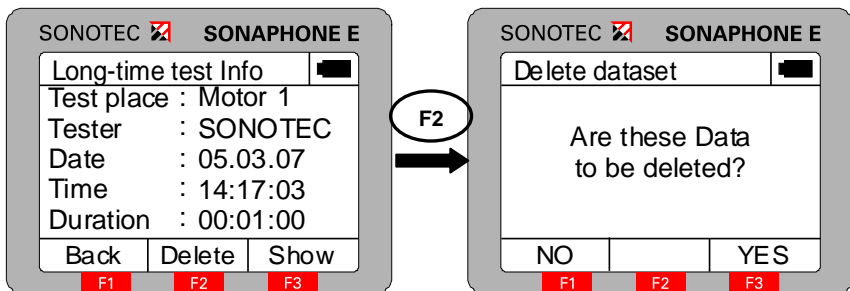

To confirm, press function key F3, to cancel this action press F1.

5. Start/overwrite Long-time test selected

By pressing function key “F3” you have the option of starting a Long-time test that is already parameterised, or overwriting an existing Long-time test.

Single test

Once the individual test has been selected, a summary of all individual tests created previously, with their respective testing sites and corresponding status, appears. The test data, that has to be stored, is filed in the Single test marked “active”.

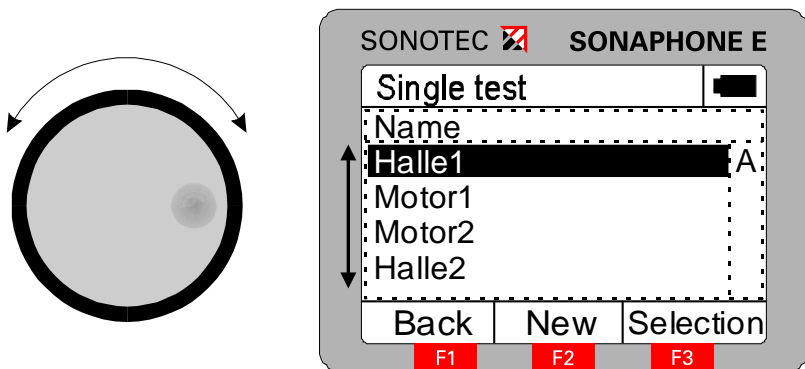

By pressing function key “F2” you can create a new Single test, by turning the rotary knob you can edit the current Single test, and you are able to activate the selected Single test by pressing “F3”.

The result of activating a Single test is that the test values are stored in this individual test within the test mode. Only one Single test at a time can have the “active” status; it is not possible to activate more than one Single test simultaneously. A Single test is edited or created in the following menu:

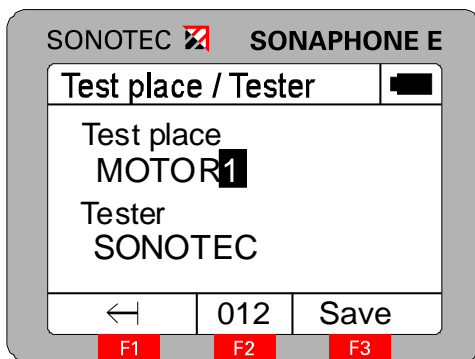

The character to be edited is selected by pressing the rotary knob and set by turning it. To edit the last character again press the Button “F1”. Press “F3” to store both the tester’s name and the test site for the corresponding Single test.

The test values are stored in the test mode by pressing the rotary knob. The following data is stored for each test:

- Date / time
- Type of probe
- Test mode / mixer frequency
- Ultrasonic test value
- Temperature value

Archiving the individual tests is only possible by using the PC software SONAPHONE Communicator, available as an accessory tool.

4.7 Test parameters

Note

Altering all test parameters have a direct influence on the test values displayed. In order to ensure reproducibility, tests which have to be compared must be recorded with identical test parameters.

Device reset

Pressing key „F1“ when the splash screen is displayed resets all test parameters to the delivery status.

Averaging time:	4 s
Tester:	SONOTEC
Mixer frequency:	40 kHz
Check mode:	logarithmic
Temperature:	°C

Notice: The test values stored in the device are not affected by the device reset. Only the test parameters are reset to the initial settings!

Setting the averaging time

The SONAPHONE E provides the option of averaging the test values recorded over a variable period. The time is set between 0 and 10 seconds in half second increments in the Averaging time menu. By turning the rotary knob the settings can be changed and stored in the device. By pressing of „F1“ you can reach the menu test parameters and by pressing „F3“ you can leave the settings and return to the test monitor.

Setting the tester

In this menu, you have the option of entering 8-character-long designations for the tester. To switch between character sets (*ABC* → *abc* → *012* → *;<*), press function key “F2”.

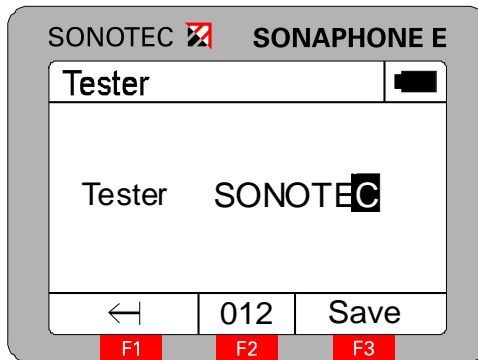

The character to be edited is selected by pressing the rotary knob and set by turning it. Press “F3” to store the tester’s name in the device.

Setting the mixer frequency

In the SONAPHONE E, ultrasound is transformed into audible sound by a frequency conversion process. The unit provides the option of setting the working frequency via the mixer frequency. The frequency range can be set between 20 and 60 kHz, in increments of 2 kHz. The default value is 40 kHz. By turning the rotary knob the settings can be changed and stored in the device. By pressing of „F1“ you can reach the menu test parameters and by pressing „F3“ you can leave the settings and return to the test monitor.

Notice: Changing the mixer frequency makes only sense when using the probe for structure-borne ultrasound L 62, since this probe has the necessary bandwidth.

Setting the test mode

The SONAPHONE E has two different display modes for the ultrasonic test value, the linear mode (linear scale 0...240) and the logarithmic mode (logarithmic scale 0...140). This can be set in the mode menu. By turning the rotary knob the settings can be changed and stored in the device. By pressing of „F1“ you can reach the menu test parameters and by pressing „F3“ you can leave the settings and return to the test monitor.

Setting the temperature display

The SONAPHONE E provides the option of showing the temperature in °C or in °F. The switch over between the two types of display can be done in this menu. By turning the rotary knob the settings can be changed and stored in the device. By pressing of „F1“ you can reach the menu test parameters and by pressing „F3“ you can leave the settings and return to the test monitor.

4.8 Settings

Date/Time

In this menu item, the date and time of day are set. You can select the desired element by pressing the rotary knob and set the desired value by turning it. It is not possible to set the seconds. These are reset to “00” when the menu is opened.

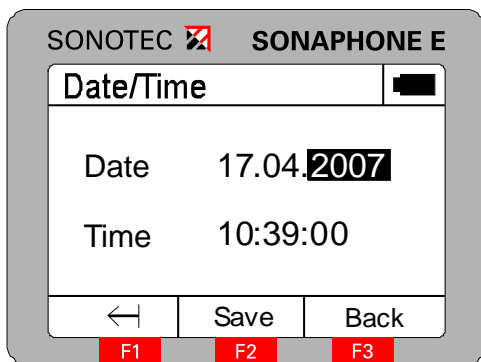

The element to be edited is selected by pressing the rotary knob, and set by turning it. To edit the last element again press the function key F1. Pressing function key F2 stores the time. Pressing function key F3 deletes the settings and returns the unit to the previous menu.

Auto Power Off

The Auto–Power Off function allows the SONAPHONE E to be switched off automatically after a set length of time. Times between 1 and 25 minutes can be set in one minute increments by turning the rotary knob. By pressing of „F1“ you can reach the previous menu and by pressing „F3“ you can return to the test mode.

Auto Light Off

The Auto Light Off function allows the display background lighting to be switched off automatically after a set length of time. Times between 0 and 2 minutes can be set in 30 second increments by turning the rotary knob. Press function key F1 to return to the previous menu and F3 return to the test mode.

Contrast

In order to adjust the readability of the display to the particular conditions it may be necessary to adjust individually the contrast. This can be done in the contrast menu by turning the rotary knob. The changes take effect immediately on the screen.

Language

The menu prompts on the SONAPHONE E can be either in German or in English. This is set in the language menu by turning the rotary knob. Press function key F1 to return to the previous menu and F3 to return to the test mode.

5 Using the probes

5.1 Air-borne sound probe L60

The L60 probe for air-borne ultrasound serves for general detection of leakages in excess pressure and in vacuum range. The slot for probes is provided with a notch which indicates the correct position for insertion. Install the required probe in the specified position. You must feel the connector click into place.



ATTENTION!

When placing the directional tube onto the air-borne probe L50 the tube could detach from the rubber grommet and damage the probe grid. Put the rubber grommet very carefully over the probe and never push with the tube.

The precision of location is increased by mounting the directional tube. For precise fault location mount the tip onto the directional tube as well.

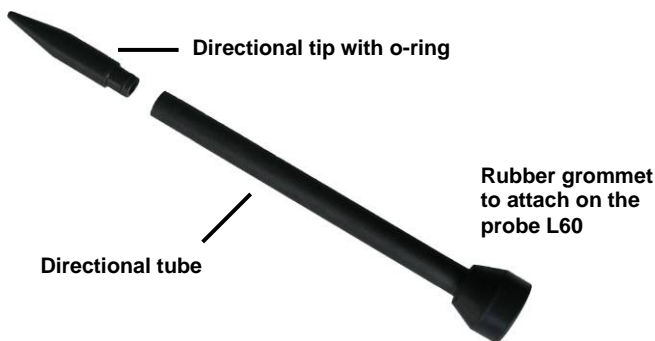

If the leak cannot be located with the probe mounted directly on the SONAPHONE E, the probe extension cable can be used.

The acoustic horn serves as attachment for airborne sound probe L60 to increase the range up to 5 ... 6 meter.



5.2 Structure-borne sound probe L61 for valve inspection (oil and water resistant)

The L61 probe for structure-borne ultrasound is especially suitable for the determination of the ultrasound level at defective and damaged fittings (valves or gate valves). It is used for example to trace inner leaks, to detect defects at the valve ball or the valve seat or to track errors at rotating equipment.



Since the probe for structure-borne ultrasound is watertight, it can also be used for ultrasonic inspections in moist environments or in water systems. After the use, the probe must be dried.

5.3 Structure-borne sound probe L62 for long-time tests and detection of bearing wear

The probe L62 for structure-borne ultrasound is used to detect ultrasound in solid objects, e.g. for the proof of bearing wear.



It has to be pressed gently by hand against the spot that has to be examined. In order to achieve reproducible results, the contact pressure and direction must be kept constant.

Notice: For optimising the test procedure the mixer frequency of the device can be changed (section 4.7) between 20 and 60 kHz in 2 kHz increments. Changing the mixer frequency affects the shown test values directly. In order to ensure reproducibility, values that have to be compared must be recorded with identical mixer frequencies.

CAUTION!

When using the L62 probe for structure-borne ultrasound, observe item 3 of the general safety precautions.

5.4 Flexible air-borne sound probe L63

The flexible probe for air-borne ultrasound serves to detect ultrasound at areas that are particularly difficult to reach.

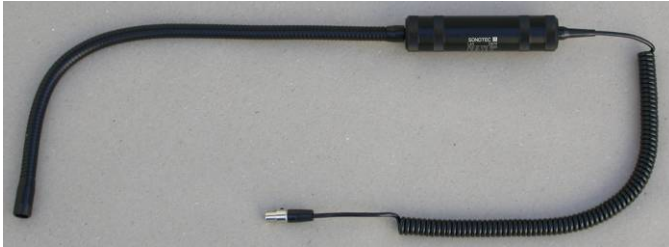

CAUTION!

When using the flexible air-borne sound probe L63, observe Item 2 of the general safety precautions.

6 Using accessories

6.1 Telescoping rod

The telescoping rod increases the reach when handling the probes. To use it, clamp the probe in the rotatable clamp and connect the plug connector near the clamp. The telescoping rod is connected by cable to the SONAPHONE E. The length of the telescoping rod is continuously adjustable from about 1.70 metres to about 3 metres. To do this, loosen the black coupling ring between the inner and outer tubes of the telescoping rod. When contracting the telescoping rod, carefully draw the cable out of the outer tube and wrap the cable.



CAUTION!

When using the telescoping rod, observe item 2 of the general safety precautions.

6.2 Surface temperature sensor

Temperatures between 0 °C and 800 °C can be measured using the surface temperature sensor. However, in hazardous areas, only temperatures up to 450 °C will be encountered.

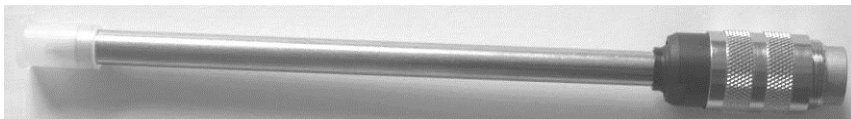

The surface temperature sensor can either be plugged into the SONAPHONE E directly or by using the extension cable.



If no temperature sensor is plugged in, (---) will be shown on the display.

CAUTION!

In hazardous areas, only the surface temperature sensor supplied by SONOTEC Ultraschallsensorik Halle GmbH may be used.

Note!

Before starting the measurement make sure, that the temperature of the SONAPHONE E corresponds to the surrounding temperature, because the measurement of a thermocouple is based on a comparative measuring procedure. For this purpose the temperature difference between the thermocouple junction (probe tip) and the reference junction is determined. The cold junction is the SONAPHONE E.

6.3 Using the grounding set

When using the ultrasonic probes L60 and L61 in Ex-zone 0, the casing of the probes must be connected to the local equipotential bonding conductor. Only the grounding set supplied by SONOTEC Ultraschallsensorik Halle GmbH may be used for this purpose.

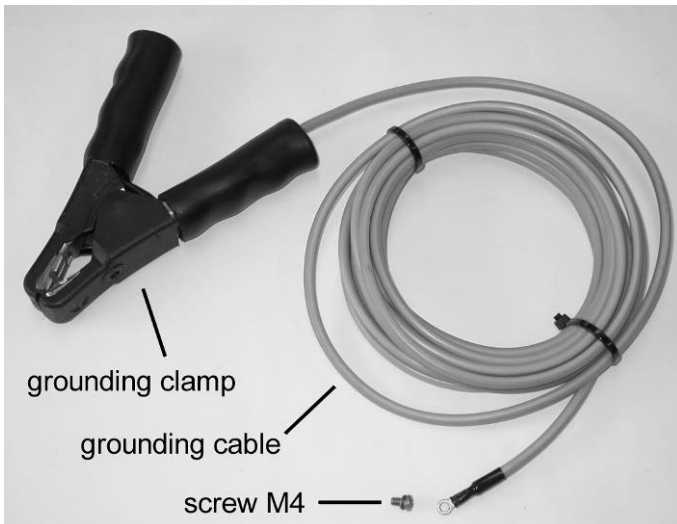

Before taking probes L60 or L61 into the Ex-zone 0, connect the grounding set in the following order!

1. Connect the probe L60 or L61 by means of the M4 screw. Screw the M4 screw into the side thread on the casing of the probe and tighten it with a suitable tool.
2. Clamp the grounding clamp to the local equipotential bonding conductor. Connect and position the grounding set in the way that it also secures the probe from falling (in order to prevent friction or impact sparks if the probe should drop onto a metal surface).
3. Now, the probe can be taken into the Ex-zone 0!

The grounding cable must not be rolled up in a hazardous area!

7 PC connection & data transfer

CAUTION!

The SONAPHONE E should only be connected to a PC if the battery compartment lid is closed! Opening the battery compartment lid while the unit is connected to the PC can result in damages to the unit!

The SONAPHONE E can be connected to a computer using a USB cable. SONAPHONE Communicator software is needed for the device communication with the computer. This contains all necessary drivers to log the SONAPHONE E into the operating system and to ensure a power supply to the unit through the PC. The operation on a PC is not possible without these drivers. The SONAPHONE Communicator provides the following functions:

- Reading out and managing Single tests
- Pre-parameterising Single tests
- Reading out and managing Long-time tests
- Pre-parameterising Long-time tests
- Archiving test data
- Performing online tests
- Parameterising the device
- Memory management

The installation program for the SONAPHONE Communicator software starts automatically when the installation CD is inserted in the drive. If this does not happen, start the program SETUP.EXE on the installation CD manually. Then follow the instructions that appear on your computer screen.

7.1 Directory structure of the installation CD

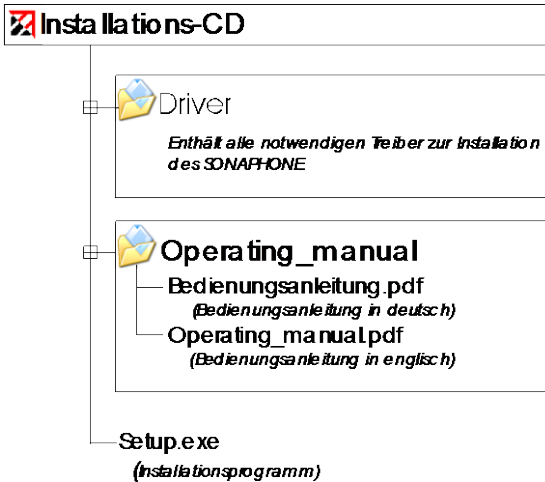

7.2 Installation for Windows XP / Windows Vista

Installation of the driver unit

When connecting the SONAPHONE E with the PC for the first time, a dialog for the installation of the driver unit opens:

Step 1:



Windows Update

In this window, choose the option: „No, not this time“. Pressing the key „Next >“ leads to the next installation step.

Step 2:

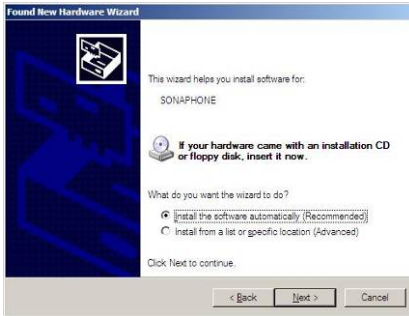

Insert the driver CD

After the insertion of the CD for the SONAPHONE Communicator the installation continues automatically. In case it will not work, press the key „Next >“.

All drivers, which are needed for the operation of the SONAPHONE E, can be found in the index: „CD-drive:\Driver\“. In case there is no automatic identification as explained in step 2, you can choose menu item „Install from a list or specific location“, in order to choose the driver on the CD manually.

Step 3:



Windows Logo Test

By pressing „Continue Anyway“ all necessary drivers are installed on the PC. After successful driver installation a new window appears, in which you can finish the installation by pressing „Finish“.

Installation of the SONAPHONE Communicator

The beginning of the installation programme for the PC-Software „SONAPHONE Communicator“ happens automatically right after the insertion of the installation CD. In case it will not happen automatically, please start the „setup.exe“ on the installation CD manually. Please follow afterwards the directions on the screen of your PC.

7.3 Installation for Windows 7

After the insertion of the installation CD the setup starts automatically. In the case that the automatic start of the program does not work, the <setup.exe> has to be started manually from the installation CD. The following window opens:



By clicking on <Continue> the setup automatically checks if you already have installed a driver for the SONAPHONE E. If this has not happened already, the following window opens:

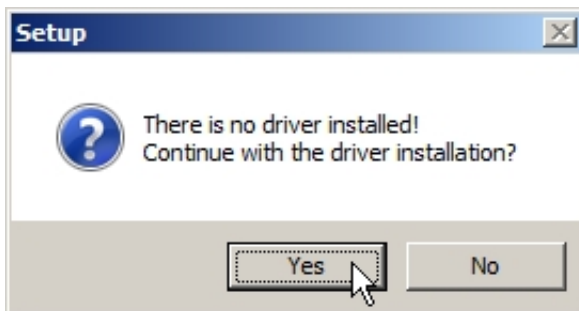

By clicking on <Yes> the installation of the driver starts. In the next step you have to connect the SONAPHONE E with the Computer via USB cable. If the device is already connected with the Computer, please interrupt the connection and connect them again. After connecting the SONAPHONE E with the Computer, two balloon tips appear on the status bar.



You can ignore these messages or close them by clicking on <X>. Now you can continue with the driver installation by clicking on <OK>:

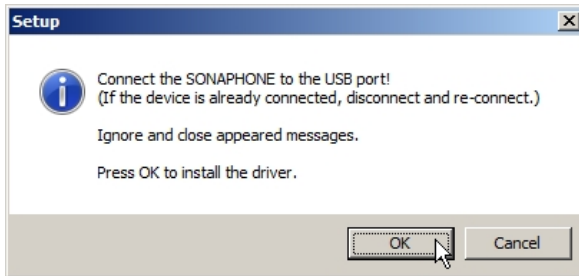

The “new hardware wizard” opens. By clicking on “Continue” the driver installation is performed. The following window opens:

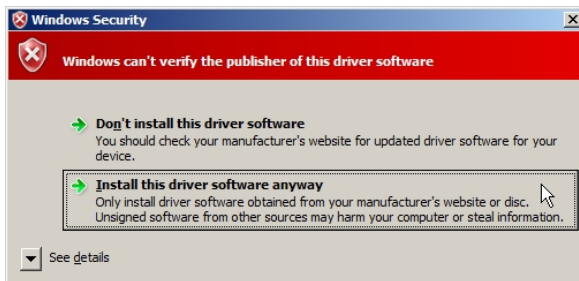

Click on <Install this driver software anyway> and in the following window on <Finish>. The driver installation is finished and the setup for the installation of the SONAPHONE E Communicator will be continued. Follow the instructions on the monitor.

7.4 Power supply via USB

The SONAPHONE E can be supplied (depending on the PC) via USB interface of the connected PC. If this is not possible, the following window appears when starting the SONAPHONE Communicator:

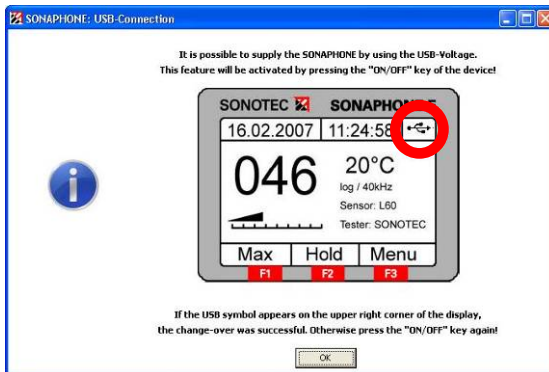

You are asked to switch off the SONAPHONE E. Appears a USB symbol in the upper right corner after having pressed „ON/OFF“, the switching was successful. Otherwise, you have to press „ON/OFF“ one more time. If the device will be switched off by pressing „ON/OFF“, there is no power supply via USB.

Notice: In case the window shown above does not appear after having started the SONAPHONE Communicator, there is either no SONAPHONE E connected to the PC or the PC does not supply power for the SONAPHONE E.

8 Trouble shooting

Not every malfunction necessarily involves an actual defect of the equipment. Time and money can be saved if you are able to correct simple faults yourself. The following notes are intended to help do so:

Fault	Possible cause	Remedy
Device cannot be switched on	Batteries are empty	Insert fresh batteries
No acoustic signal detectable	Volume control set too low	Adjust volume
	Probe is not connected properly	Put in the plug completely
	Headphones are not connected properly	Put in the plug completely
	Unit switched off automatically	Switch unit on again
	Defective probe	Check with another probe

9 Technical specifications

Operating frequency	Ca. 40 kHz (20-60 kHz width 2 kHz increments)
Connections	Ultrasonic sensor Temperature sensor Headphone USB interface (USB 2.0)
Display	Graphical display Background lighting Menu control
Temperature measurement range	0 °C ... 800 °C
Dimensions	190 mm x 110 mm x 85 mm
Weight	Ca. 650 g
Operating temperature	0 ... +40 °C
Storage temperature	-10 ... +50 °C
Explosion protection	Unit: II2G Ex ia IIC T4 Gb Probes L60 & L61: II1G Ex ia IIB T4 Ga u. II2G Ex ia IIC T4 Gb Probes L62 & L63: II2G Ex ia IIC T4 Gb Designation: ZELM 03 ATEX 0130X

10 Warranty

SONOTEC Ultraschallsensorik Halle GmbH provides a warranty of twelve months from the date of sale for the SONAPHONE E and their accessories. Within the warranty period, SONOTEC Ultraschallsensorik Halle GmbH will correct all defects caused by faults in material or manufacturing without extra charge. SONOTEC Ultraschallsensorik Halle GmbH will fulfil the warranty agreement by either repairing or replacing the defective device or component.

Not covered by the warranty are primary or secondary batteries and damages due to incorrect use, abrasion, or interference with the equipment. Furthermore, the warranty does not cover those defects which affect the value or usability of the equipment only insignificantly.

→ We reserve the right to make technical changes without notice. Supply is based on availability.